



IPRK 92

Retro-reflective photoelectric sensors with polarisation filter



0.2 ... 12.5 m



- Compact construction with glass optics and robust zinc diecast housing, protection class IP 67 for industrial application
- Warning output autoControl for increased availability
- Electrical connection with M12 connector, cable or 6-pin standard plug



Accessories:

(available separately)

- Mounting systems (BT 92, UMS 1)
- M12 connectors (KD ...)
- Ready-made cables (KB ...)
- Reflectors
- Reflective tapes

Dimensioned drawing

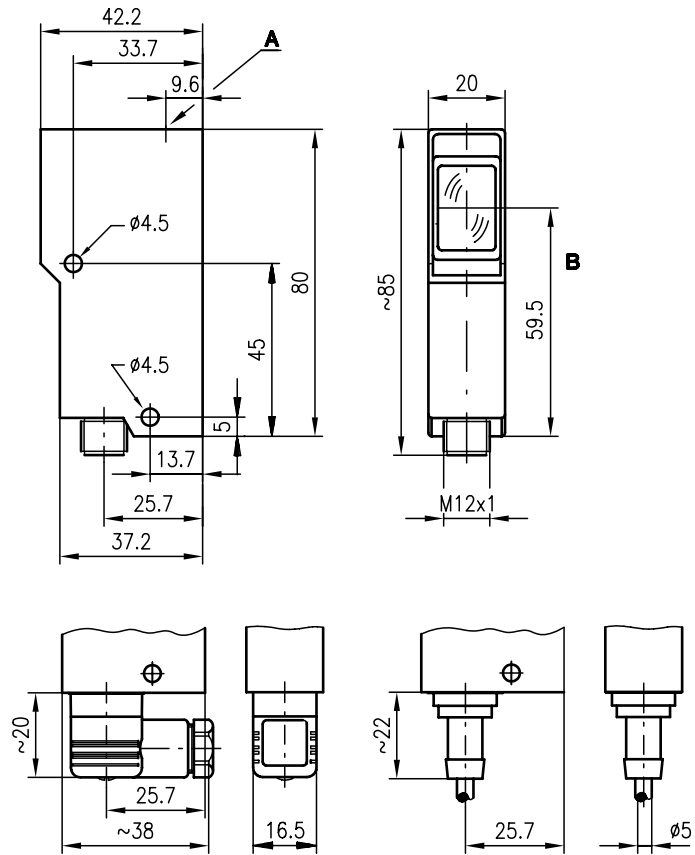

IPRK 92/4 S
IPRK 92/4.8 S

IPRK 92/4,6000

- A Indicator diode
- B Optical axis

Electrical connection

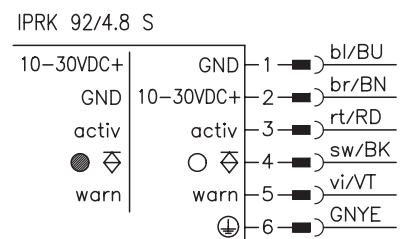
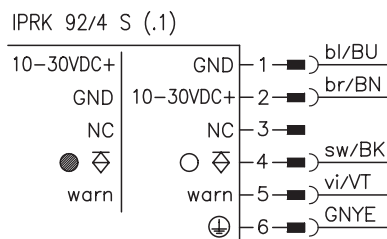
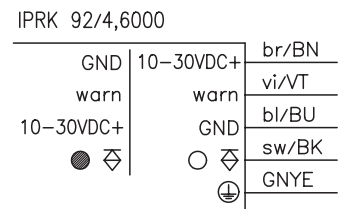
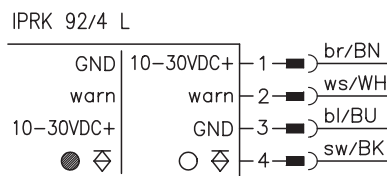

We reserve the right to make changes • 92_b02e.fm

Specifications

Optical data

Typ. operating range limit (TK(S) 100x100) ¹⁾	0.2 ... 12.5m
Operating range ²⁾	see table
Light source	LED (modulated light)
Wavelength	660nm (visible red light, polarised)

Timing

Switching frequency	500Hz
Response time	1 ms
Delay before start-up	≤ 100ms

Electrical data

Operating voltage U_B	10 ... 30VDC (incl. residual ripple)
Residual ripple	≤ 15% of U_B
Bias current	≤ 30mA
Switching output	PNP transistor output
Function characteristics	light or dark switching (by reversing the polarity of U_B)
Signal voltage high/low	≥ ($U_B - 2V$) / ≤ 2V
Output current	max. 100mA

Indicators

LED yellow	light path free
LED yellow flashing	light path free, no performance reserve

Mechanical data

Housing	diecast zinc
Optics	glass
Weight	140g
Connection type	M12 connector, 6-pin standard plug or cable: length 6m, 3x0.25mm ² +1x0.5mm ²

Environmental data

Ambient temp. (operation/storage)	-20°C ... +60°C / -30°C ... +70°C
VDE safety class	I for S types and cable version
VDE safety class ³⁾	II for L types (M12 connector)
Protective circuit ⁴⁾	2, 3
Protection class	IP 67, IP 65 for IPRK 92/4...S
LED class	1 (acc. to EN 60825-1)
Standards applied	IEC 60947-5-2

Options

Activation input activ	≥ 8V / ≤ 2V or not connected
Transmitter active/not active	1 ms
Activation/disable delay	4.7KΩ ± 10%
Input resistance	PNP transistor, counting principle
Warning output autoControl warn	≥ ($U_B - 2V$) / ≤ 2V
Signal voltage high/low	max. 100mA
Output current	

- 1) Typ. operating range limit: max. attainable range without performance reserve
- 2) Operating range: recommended range with performance reserve
- 3) Rating voltage 250 VAC
- 4) 2=polarity reversal protection, 3=short-circuit protection for all outputs

Order guide

	Designation	Part No.
with 6-pin standard plug		
without transmitter activation	IPRK 92/4 S	500 13059
with activation input	IPRK 92/4.8 S	500 14199
with M12 connector	IPRK 92/4 L	500 18778
with cable connection 6m	IPRK 92/4, 6000	500 23962
with 6-pin standard plug	IPRK 92/4 S.1	500 20358
without cable connector		

Tables

Reflectors			Operating range
1	TK(S)	100x100	0.2 ... 8.5m
2	TK(S)	50x50	0.2 ... 7.0m
3	TK(S)	30x50	0.2 ... 3.5m
4	TK(S)	20x40	0.2 ... 3.0m
5	Tape 2	100x100	0.3 ... 3.0m

1	0.2	8.5	12.5
2	0.2	7.0	10
3	0.2	3.5	5.5
4	0.2	3.0	4.5
5	0.2	3.0	4.5

- Operating range [m]
- Typ. operating range limit [m]

- TK ... = adhesive
- TKS ... = screw type
- Tape 2 = adhesive

Diagrams

Typ. response behaviour (TK 100x100)

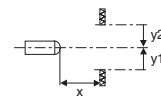
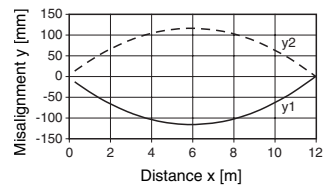

Remarks

- The retro-reflective photoelectric sensor is also available with integrated AS-i chip for direct connection to the AS-i system.